

PROMINENTTM
SOLUTIONS WITH INNOVATION

Holding the power to CHANGE

Manufacturer exporter of all types : Tool disc & Tool Holders, VDI Tool Disc , VDI Tool Holders , BMT Tool Disc and Holders, Reduction Sleeves, Jaws & subsidiary accessories for CNC Turning & Turnmill Centers



www.prominenttools.com

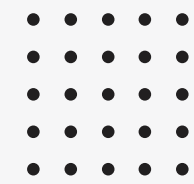
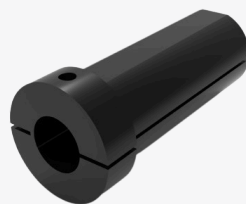
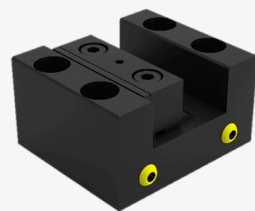
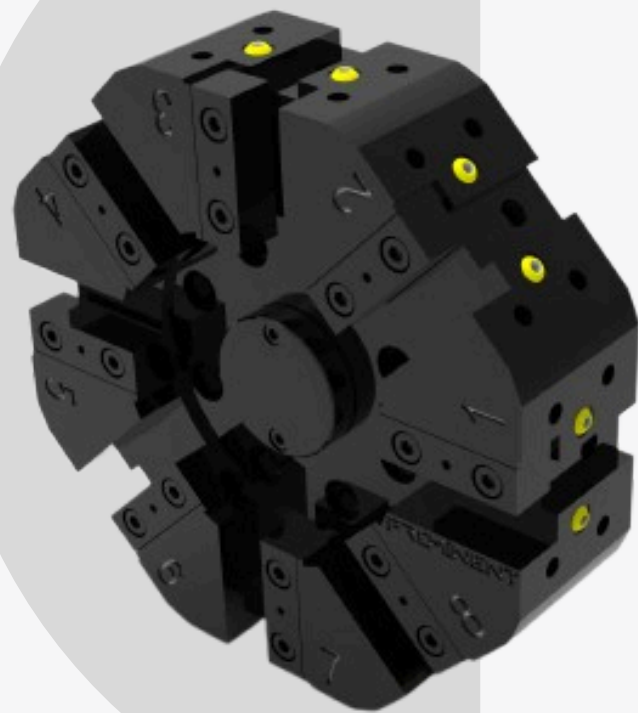
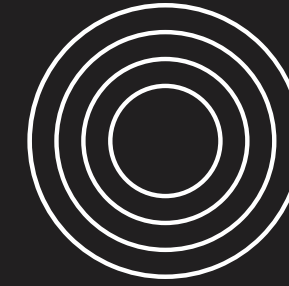

TABLE OF CONTENTS

✓ About Company	03
✓ Road map	04
✓ Vision and Mission	06
✓ Our product range	07
✓ Our Facilities	10
✓ Latest project	13
✓ Contact Info	16



ABOUT COMPANY



- **PROMINENT** Machine Tools was started in 2021 with 20+ years of experience in machine tools Industry.
- Today we fully geared-up to manufacture & supply the ever-growing needs of customers in the field of CNC Turning & Turnmill center such as Slotted discs & holders ,VDI disc & tool holders, BMT tool holders, Reduction sleeves, Jaws, collect chucks, etc...
- We are committed to meet and exceed customer expectations in Quality delivery cost.



**MANUFACTURING
EXTENSION UNIT**



HEAD OFFICE



ROAD MAP

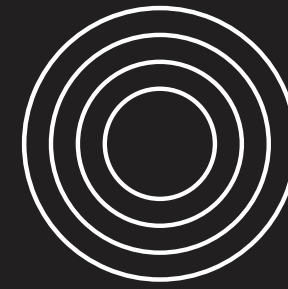

PROMINENT TOOLS

2021

Started with world class bench mark to manufacturing and supplier of VDI Tool disc & Holders



2022

• Started the Manufacture of Precision machining components to aerospace industries



2023

Manufacture of BMT Tool Disc & Tool Holders



2024

Started Exclusively for manufacturing of Tool Disc & Tool Holders for CNC Turning & Turnmill centers.



www.prominenttools.com



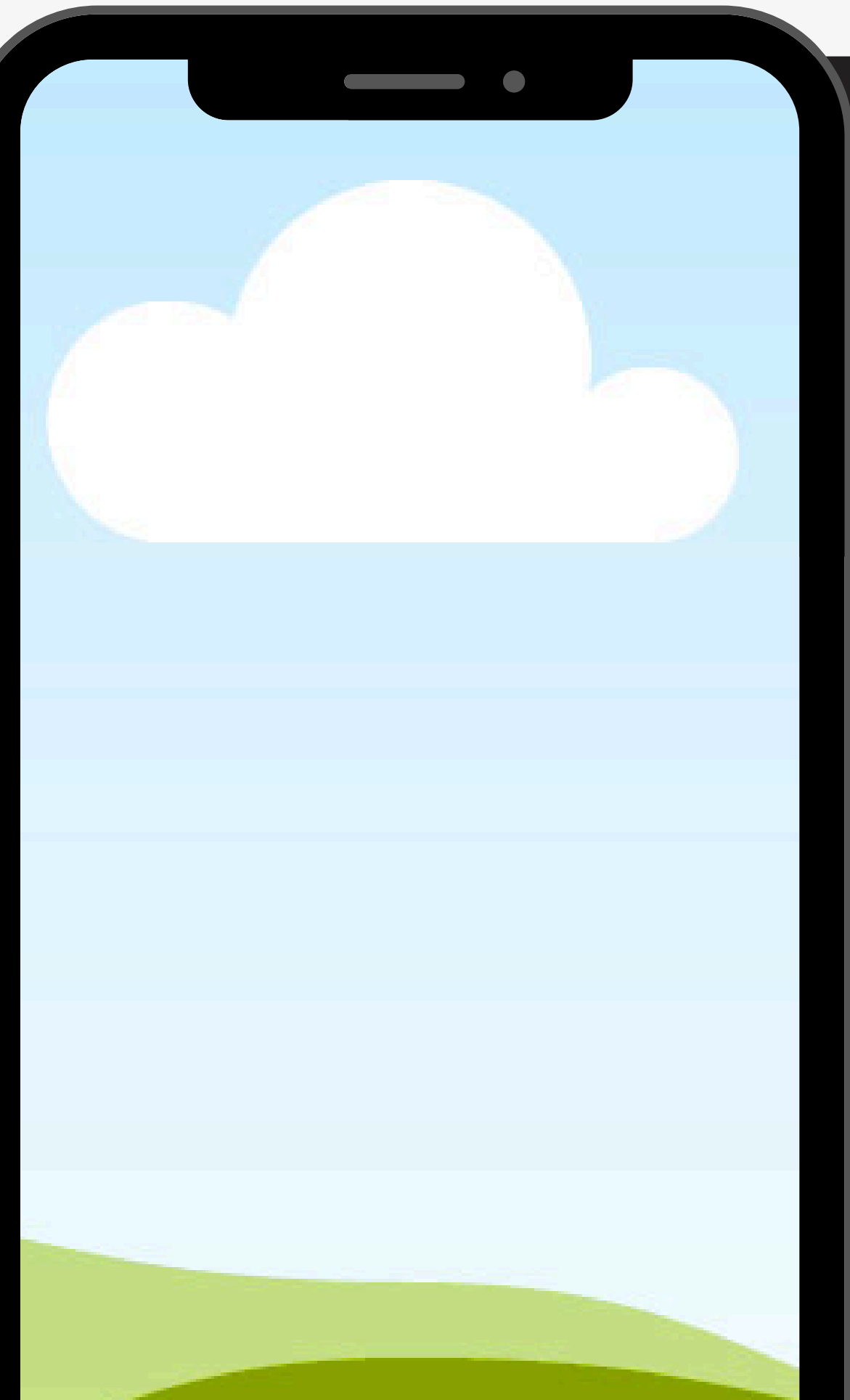

MEET THE FOUNDER



It is indeed our pleasure to present our profile too everyone. With the 20+ years experience in the field of CNC Machine tool Industry. We are always available to support your any queries regarding CNC Machine tool & Accessories

Gunasekaran GR
CEO, FOUNDER

www.prominenttools.com

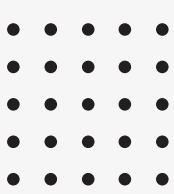

PROMINENT
TOOLS



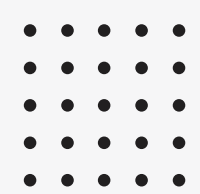

VISION AND MISSION

MISSION

Our products has to serve all the Indian machine tool industries to solve all kind of machining solutions within 2026.

VISION

Have to give support to all the Machine Builders in world for the effective and ease manufacturing within 2030.

OUR **PRODUCT RANGE**



Slotted tool disc, Tool holders, Sleeves & Machining Center Accessories for CNC Turning & Turnmill centers

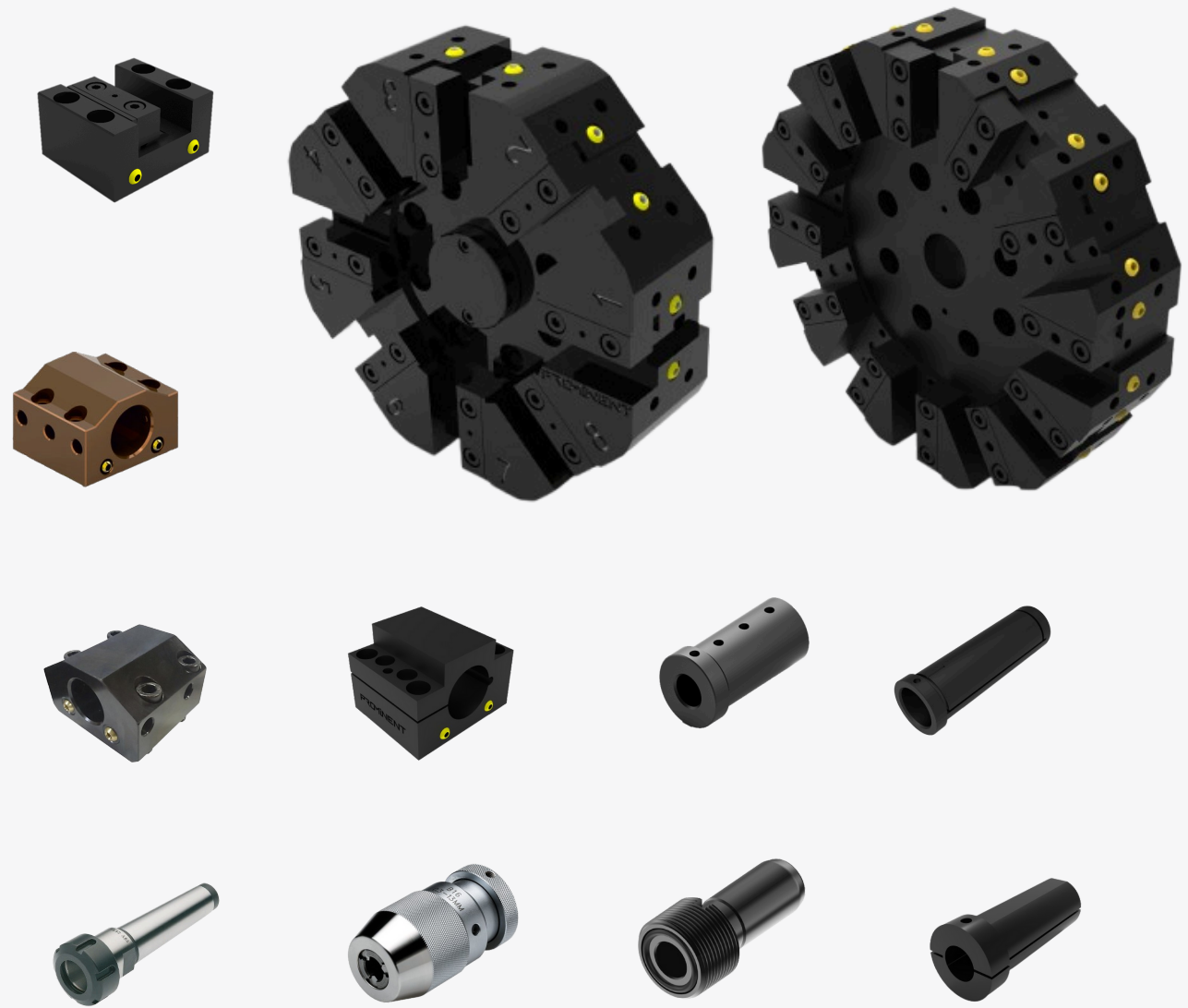

Tool Disc & Tool Holders defining feature lies in its ability to be bolted directly onto the lathe's cross-slide, ensuring a rigid and compact configuration. This design promotes enhanced stability during machining operations, contributing to heightened precision and reduced vibration.



***Customized designs also available**

www.prominenttools.com

OUR PRODUCT RANGE



VDI Tool disc & Tool holders and their respective sleeves for CNC Turning & Turnmill centers



VDI modular design follows international standards, ensuring compatibility across various lathe models and brands. The distinctive features and benefits of VDI Discs, lie in their adaptability and ease of tool change. Employing a quick-change system, VDI turrets facilitate rapid swapping of toolholders, significantly reducing downtime during machining operations. Furthermore, the standardized interface enhances precision and repeatability, promoting consistent machining quality.



OUR **PRODUCT RANGE**



 **BMT Tool disc, Tool holders and their respective sleeves for CNC Turning & Turnmill centers**



BMT Tool disc & Holders encompass their modular nature, allowing for quick and efficient tool changes. Active tool holders, coupled with a sturdy clamping mechanism, ensure a secure grip on cutting tools, minimizing the risk of deflection



***Customized designs also available**

www.prominenttools.com

OUR FACILITIES

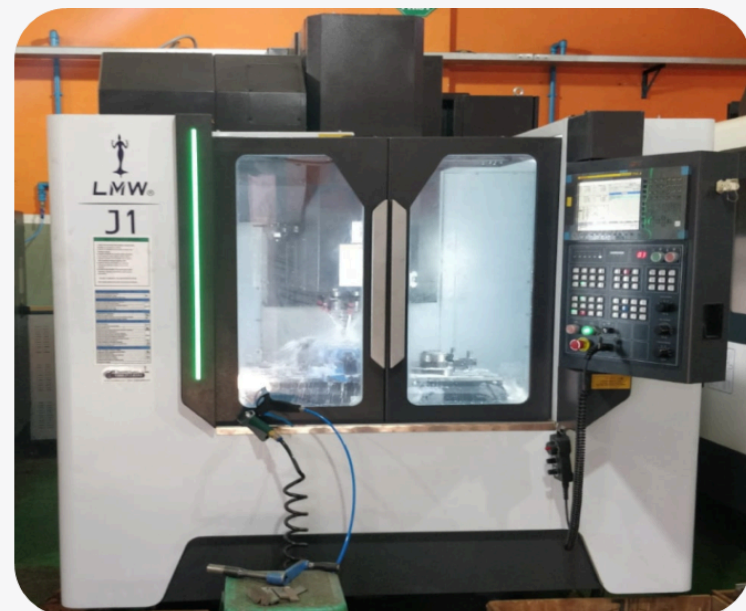
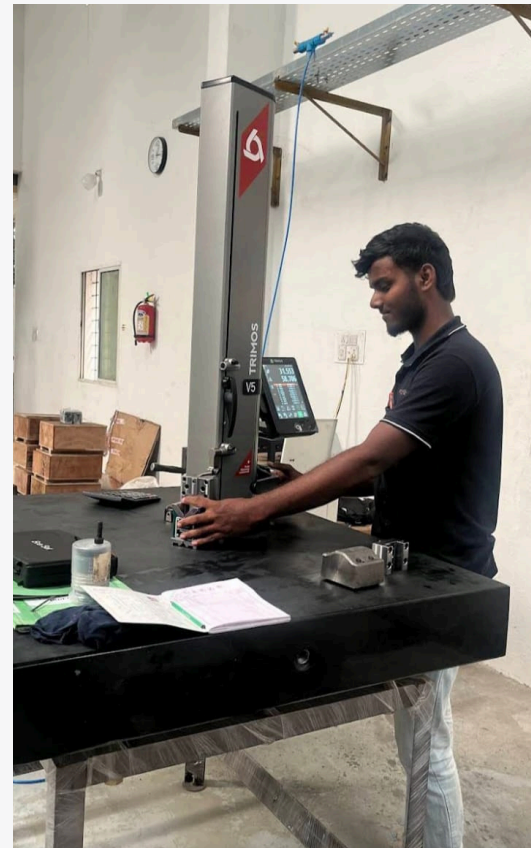



THE PROCESS



01
CNC TURNING

02
CNC GRINDING

03
CNC MILLING



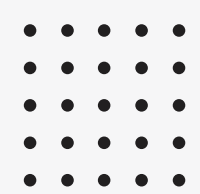

QUALITY

Measuring Quality is crucial for continuous improvement and maintaining competitiveness. Regular measurement identifies trends, uncovers the problems and validate the effectiveness of quality initiatives. As a quality **PROMINENT** confidently says, we will provide Ultimate Customer satisfaction by Ensuring Manufacturing and supply of Precision Parts all over the world.



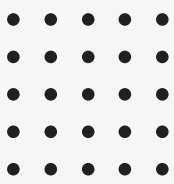

2025

LATEST PROJECT

DRIVEN TOOL HOLDERS



- Our new introductions BMT Tool Holders, VDI Tool holders DIN 69880 through coolant reduction sleeves & slit sleeves fill an important need, for more, high speed machining applications, especially in the field of aerospace industry.
- Also Driven tool holders are in development stage, soon it will introduce in the market.



ER20
Ømax=Ø12

PREVIOUS EVENTS



AWARDS & CERTIFICATIONS

2021-2024



PROMINENT



CONTACT US

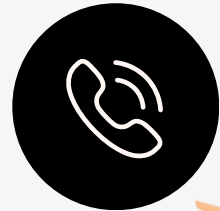

080 2658 1755
+91 99167 01312



info@prominentautotech.com,
guna@prominentautotech.com



Prominent Auto tech (Head Office / Manufacturing Facility)

310×311/4, 8th Cross 4th Phase Peenya Industrial
Area Near NTTF, Bengaluru - 560 058.

Prominent Machine Tools (Manufacturing Extension Unit)

60/61, 10th Cross, Balaji Nagar Peenya Industrial
Area Thigalarapalya, Bengaluru - 560 058.



www.prominenttools.com

